

ECM
MANUFACTURE

Home Line 2024





Our aspiration? Your perfect espresso!

Perfection is our ambition and our motivation: We manufacture high-quality espresso machines and espresso grinders with vision and passion - quality products for unique espresso enjoyment.

Our highly motivated team, inspired by the fascinating world of espresso, unites German engineering with elegant Italian styling - an ideal synergy. Reinforced by innovative technology, the highest quality standards and exquisite handcrafted design.

Our goal is to equip you optimally, both with high-quality espresso machines and espresso grinders, and also with professional accessories to prepare the perfect espresso at home.

You are the barista!

Our promise? Excellent craftsmanship!

ECM Manufacture represents the highest quality and technical innovation. With conviction, we produce espresso machines and espresso grinders that are intricately handcrafted in our workshops in Germany and Italy.

We are committed to the continuous development of our products. When selecting materials and components, we place the highest value on excellent quality and sustainability, and therefore largely forego the use of plastic.

Our innovative ideas, technical competence, and many years of experience in manufacturing premium products guarantee you the perfect espresso experience at home.

Our team of coffee-enthusiastic employees in Germany and Italy craft our products by hand.

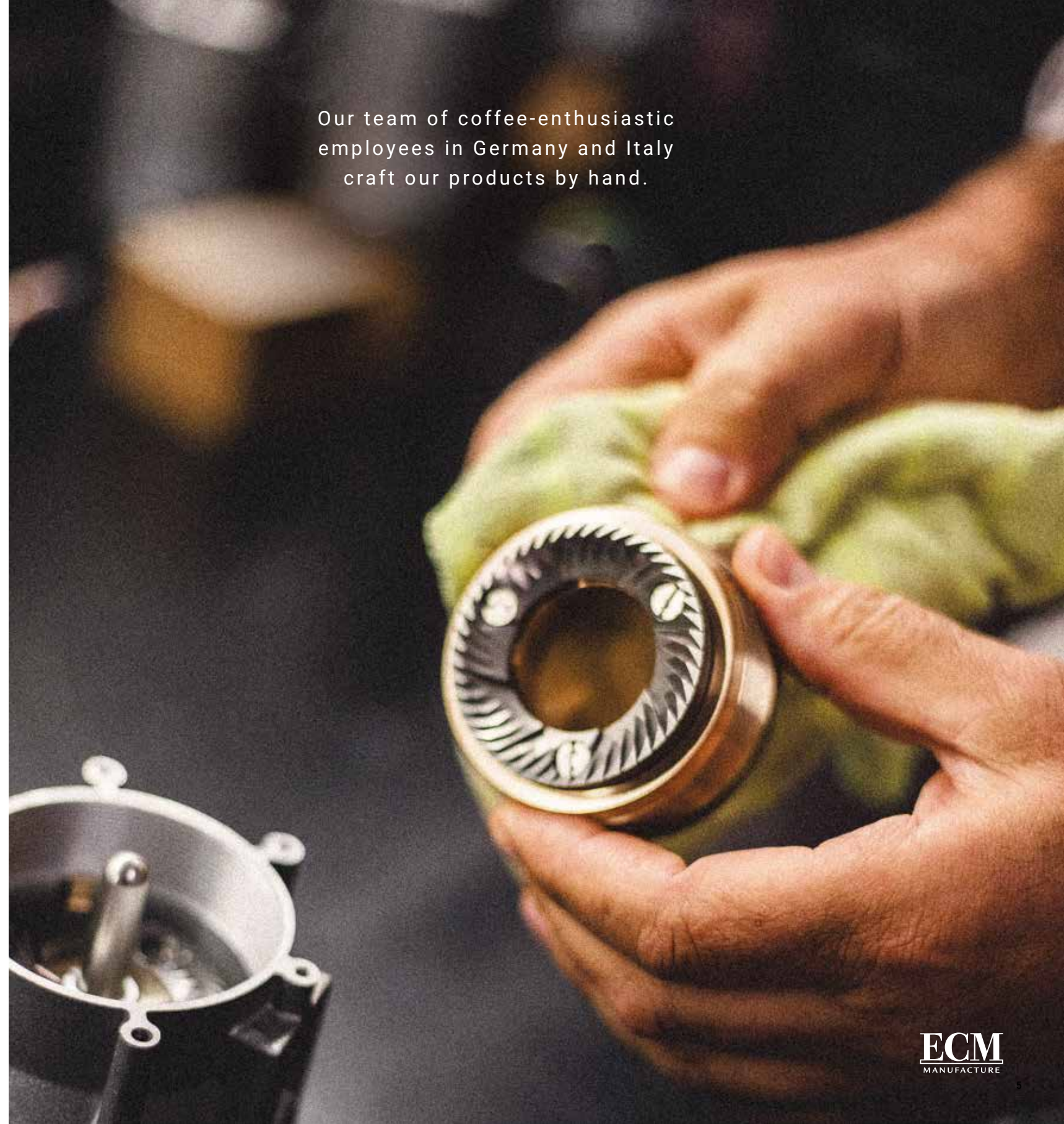

ECM Premium Technology – Thought-through Quality.

Sophisticated technology, perfectly handcrafted and elegant design - ECM premium espresso machines do not only stand for elegance but also for highest quality and optimal use.

Benefit from our expertise and the technical highlights in our machines:

Professional high-quality components from the commercial segment.

Professional quick-steam and hot-water valve technology, which is commonly found in commercial espresso machines.

Further development of the **legendary E61 brew group** with integrated innovative stainless steel brew bell.

The **innovative PID-temperature controller** that allows comfortable handling and adjustment in order to brew the perfect coffee.

The innovative PID-temperature controller
Constant temperature – guaranteed



The PID-temperature controller assures that your coffee is reliably prepared at the exact temperature you desire and that the

taste of your espresso can develop optimally. In addition, the display indicates the brewing time and allows you to change the ECO mode.

The patented ECM Brew Group
Further development of the legendary Faema E61 brew group

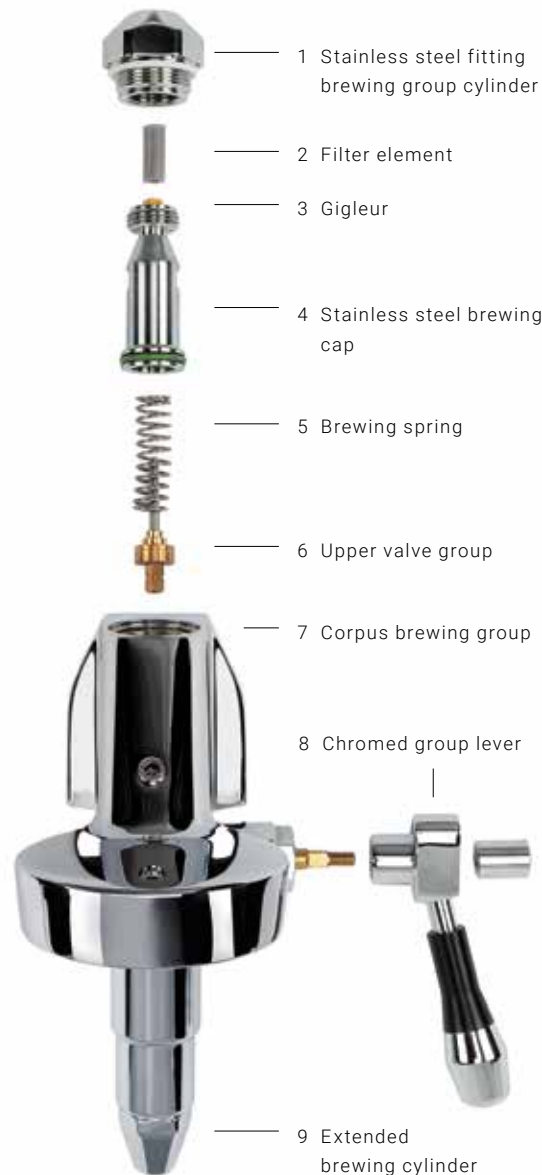

Different demands require different systems

The Single Boiler System

For the highest demands in the smallest spaces

O In the single boiler system, both the water for the brewing process and the steam are heated and transported through the same circuit. In contrast to other systems, the preparation of espresso and milk frothing takes place successively due to the different temperatures required for the preparation.

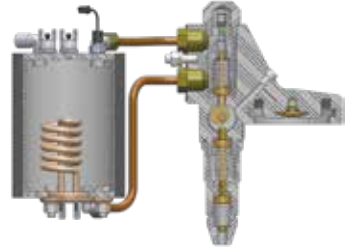

The Heat Exchanger System

Powerful technology with aroma guarantee

H Perfectly thought through: heat exchanger espresso machines have two separate water circuit systems, which allow for the simultaneous preparation of both espresso and steamed milk. Fresh water from the water tank, or direct water supply, is always used for the preparation of espresso. The optimal temperature stability is guaranteed by the thermosyphon system, which heats the brew group by permanently circulating hot water.



The Smart HX® System

Sophisticated control for the perfect espresso

+ With our new Smart HX® system – HX stands for heat exchanger – the tried and tested heat exchange technology is born anew. With the help of an additional sensor via the inflow of the brewing group, the virtually perfect temperature control of the thermosyphon is ensured. A sophisticated control system thus guarantees that the set temperature is maintained. In this way, the temperature consistency of a single boiler machine is combined with the flexibility of a heat exchanger machine. Thanks to the practical Flush Advisor, the Smart HX® system ensures that you can always brew your espresso at the ideal temperature. The Brew Temperature Control in the Advanced Settings menu ensures individually adjustable brewing temperature stability.

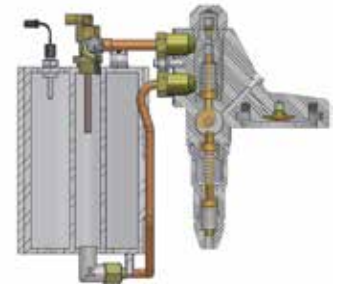

The Dual Boiler System

Maximum flexibility, maximum heating speed

oo Dual boiler machines guarantee a maximum in flexibility. There are two separate boilers for brewing coffee, and for the preparation of steam and hot water. As a result, you can adjust the temperatures for brewing coffee and for steam separate from another, (Furthermore, the steam boiler can be switched off if only espresso is called for.) The unique extra-heating system in the brew group designed by us also ensures the ideal and constant temperature for espresso preparation in absolute record time.

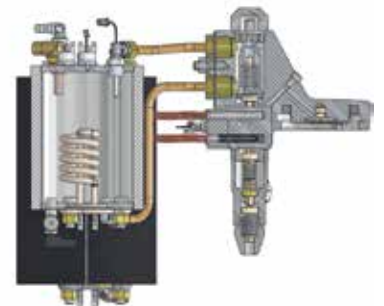



we live
espresso

Get the
best
out of
your
espresso.





Single boiler espresso machines

It's simply about espresso.

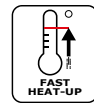

Puristika

Our PURISTIKA, fabricated from the finest quality materials, is a must for all die hard espresso fans; those who focus purely on the **essential and unadulterated enjoyment of espresso.** Through the application of the innovative PID and the externally adjustable expansion valve, you are in control of your desired temperature, as well as pump pressure. So that you can bring out all of those delicate and versatile nuances your coffee

has to offer. Thanks to its compact construction and the practical transport box, the PURISTIKA isn't limited to the kitchen and living room. The rounded anthracite housing and the midnight blue accents on the valve and pressure gauge, not to mention the external glass water reservoir, make the PURISTIKA **an absolute must-have designer piece.**





ECM
MANUFACTURE



Single boiler espresso machines

Space-saving and professional.
For absolute coffee enjoyment.

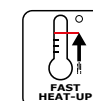

Classika PID

Do you dream of delicious homemade espresso, but have limited space in your kitchen or workspace? Then our compact **single-circuit espresso machine**, CLASSIKA PID is the perfect solution for you. Crafted with precision in sleek stainless steel housing, it not only saves space but elevates your brewing experience with professional-grade features like the **convenient PID control**.

In short, the CLASSIKA PID offers everything you need to brew an excellent espresso. And thanks to the short heating-up phase of the machine, you never have to wait long for it either.



Heat exchanger espresso machine with vibration pump

Compact design.
Powerful technology.



Mechanika VI Slim

Our powerful and compact MECHANIKA VI SLIM is the perfect choice for smaller kitchens - or a narrow side table in a modern dining room. The unmistakable ECM design impresses with its highly polished stainless steel housing and the retro, red accented rotary valves. The technical specs on this machine are in a class of their own. The **heat exchanger boiler and vibration pump** allow for simultaneous preparation of espresso and frothed milk - just like in a real cafe.

Using the convenient flip switch on the bottom of the machine, you now also have the option of switching between **three different temperature settings** so that you can adjust the ideal temperature to your roast and taste. A lower brewing temperature is ideal for darker roasts, and a higher one for medium and light roasts. Additionally, switch to activate the Eco mode or turn the optional preinfusion on or off for an even moistening of your ground coffee.





Heat exchanger espresso machine with vibration pump

All-rounder with a discreet display



ECM
MANUFACTURE

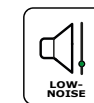

Mechanika Slim PID

Our MECHANIKA SLIM PID offers all the advantages of our popular all-rounder, Mechanika VI Slim. Additionally, it allows you to read your current settings, such as **pre-infusion**, **ECO mode**, and **temperature unit**, on the additional display.

If the water tank is empty, you will also receive a corresponding notification on the display. Furthermore, the deep blue accents on the nostalgic rotary valves give the machine a unique look.

* Our **Exclusive Line** is available at selected European dealers. These dealers are authorized service dealers who are especially experienced and trained professionals that not only provide **excellent purchasing advice**, but also give an excellent and thorough showcasing of our products in their show rooms. They are also **qualified service experts** assuring you an optimal assistance also after your purchase.



The elegant eye-catcher for home baristas: Our **heat exchanger espresso machines with rotary pumps** put real professional equipment in your kitchen. The rotary pump - which is commonly found in commercial machines - is extremely powerful and enables fast, constant and reliable brewing pressure. All the while, doing so very, very quietly ...

A further highlight of this series are the **professional quick-steam and hot-water valves**. Subtle and genius in operation: A slight movement of the valves in any direction allows for maximum release of steam and hot water. Simply perfect.



Heat exchanger espresso machines with rotary pump

Perfect professional equipment.



Technika V Profi PID

No compromises! The TECHNIKA V PROFI PID combines sophisticated technology with elegant design. The professional quick-steam and hot-water valves are made of brass and chrome and shine next to the large, and easy-to-read pressure gauges. The convenient PID controller allows for simple adjustment and guarantees stable temperature inside the boiler.



Elektronika II Profi

Perfect espresso at the push of a button? That is possible! With the ELEKTRONIKA II PROFI you can conveniently control the brewing process using the programmable brew buttons. Each button can be customized to dispense your desired coffee dose with simple push and hold programming, and the automatic back-flush program is the stuff of dreams. And, of course, everything on the inside is what you would expect from an ECM professional machine.



Smart HX® espresso machine with rotary pump

Smarter than ever before.



Mechanika Max

Our new MECHANIKA MAX offers all the convenience of a heat exchanger machine; plus, various other options to optimize your coffee experience: From the helpful **Flush Advisor**, which supports you throughout your perfect brewing process, to the **Brew Temperature Control** for an exact and stable brewing temperature, to refinements such as the precisely definable pre-infusion for optimal moistening of the coffee grounds: Whether you're an espresso beginner or a professional, the MECHANIKA MAX offers you the smart features

to match. With the timer controlled via the **PID display** and various reminder functions, the machine adapts precisely to your everyday life and needs.

Minimum space requirement, maximum performance: thanks to the efficient design, our new heat exchanger machine is extremely space-saving. The built-in rotary pump guarantees quiet yet powerful performance. The smart machine for smart espresso enjoyment.



Dual boiler espresso machine with rotary pump

Highest quality for highest expectations.
Pure lifestyle.

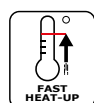

Synchronika II

You set the highest standards – for yourself, for your home, and for your espresso machine? Then the SYNCHRONIKA II is your first and best choice. It is equipped with the high-quality components of a professional espresso machine. As a **dual boiler espresso machine**, it guarantees ultimate flexibility: the two separate boilers, one for brewing espresso and one for steaming and hot water, allow the temperatures to be set independently.

Thanks to **additional heating cartridges** - with an extremely short heating time of only six and a

half minutes, our popular Synchronika got an impressive upgrade. Furthermore, even more operating comfort awaits you: the even larger display allows you to easily and precisely adjust parameters such as switch-on and switch-off times, preinfusion, etc. **according to your needs**. Beyond its functionality, the SYNCHRONIKA II is a stunner too. With its elegant powder-coated anthracite chassis and polished stainless-steel body, it's a stylish addition to any room. Plus, its large retro pressure gauges give the SYNCHRONIKA II its unforgettable style.



ECM
MANUFACTURE



Espresso grinders

The best for your beans.

For the perfect espresso grinding fresh is a must. Our on-demand grinders deliver freshly ground coffee beans in seconds: dial in your desired grind setting and let's go – full aroma directly into your portafilter.



C-Manuale 54

The C-MANUALE 54 is a functional espresso grinder in a compact design. It has a practical manual grinding function and the adjustment of the grind is graduated.

Available in either polished stainless steel with an optional red or black grinding scale, or perfectly matching the PURIST-IKA, in an anthracite color with the one-of-a-kind blue grinding scale.



C-Automatik 54

The C-AUTOMATIK 54 in polished stainless steel housing with elegant anthracite front panel offers you absolute ease of use in a sleek design.

With this compact grinder, you can precisely and continuously adjust the grind level to your needs. Moreover, the discreet display makes it easier for you to program the desired portion size and retrieve it effortlessly.



Espresso grinders



S-Manuale 64

The S-MANUALE 64 impresses with its classically simple design and user-friendly handling. Simply dial in your grind with the infinitely adjustable stepless adjustment and press the button until you have ground as much coffee as you need. Done!



Espresso grinders



V-Titan 64

Our V-TITAN 64 is a stylish espresso grinder that embodies the retro feel of the 50s blended with modern grinding comfort. The funnel in front of the grinder guarantees that the ground coffee finds its way into the center of the portafilter without any scattering. With the practical timer, the wear-resistant, titanium-coated grinding burrs and potential for hands-free use, this grinder is in a class of its own and a jewel in every kitchen.

Available in polished stainless steel or with a powder-coated anthracite housing.



S-Automatik 64

The S-AUTOMATIK 64 is equipped with a display and allows you to set the grinding time of your coffee doses to a tenth of a second. You can conveniently determine the exact time for your desired quantity directly during grinding, save it and repeat it at any time. Housing is available in stainless steel or powder-coated anthracite.

Available in polished stainless steel or with a powder-coated anthracite housing and stainless steel grinding adjustment.

Stylish accessories for your espresso grinder



1



2



3



4

- 1 – **Stainless steel lid** suitable for 500g bean hopper of the 64 series, item no. G1146
- 2 – **Stainless steel lid** suitable for the coffee funnel of the V-Titan 64, item no. G1145
- 3 – **Glass bean hopper** with stainless steel lid, suitable for the 64 series, item no. 89435
- 4 – **Stainless steel grinding gear**, suitable for the 64 series, high stability, easy change, item no. G1140



Espresso accessories

Natural wood. Superlative craft.

Elegant look in olive wood



- 1 – **Olive wood handle set**, 4 pieces with rotary valves, chrome-plated, item no. 89495
- 2 – **Olive wood handle set**, 4 pieces with lever valves, chrome-plated, item no. 89493
- 3 – **Olive wood set PURISTIKA**, 4 pieces incl. portafilter, brew lever handle, lid and foot for water tank, item no. 89497
- 4 – **Olive wood portafilter**, 1 spout, chrome-plated, item no. 89469
- 5 – **Olive wood portafilter**, 2 spout, chrome-plated, item no. 89467

- 6 – **Olive wood portafilter**, bottomless, 21g
- 7 – **Olive wood tamper**, flat, stainless steel,
- 8 – **Coffee brush** with olive wood handle,
- 9 – **Olive wood handle** for the knockbox M

- filter, chrome-plated, item no. 89465
- item no. 89491
- item no. 89520.1
- (drawer), item no. 89630.8

Made from real wood, no two pieces are alike. Wood is a natural material that will change over time with use.



ECM
MANUFACTURE



Espresso accessories

Exclusive oak wood design – the smoked oak edition



1

2

3



4

5

6



Made from real wood, no two pieces are alike. Wood is a natural material that will change over time with use.

- 1 – Smoked oak handle set, 4 pieces with rotary valves, chrome-plated, item no. 89496
- 2 – Smoked oak handle set, 4 pieces with lever valves, chrome-plated, item no. 89494
- 3 – Smoked oak tamper, flat, stainless steel, item no. 89492
- 4 – Smoked oak portafilter, 1 spout, chrome-plated, item no. 89468
- 5 – Smoked oak portafilter, 2 spout, chrome-plated, item no. 89466
- 6 – Smoked oak portafilter, bottomless, 21g filter, chrome-plated, item no. 89464



Espresso accessories



1

2

3

4



5

- 1 – Tamper with stainless steel base with handle in high-quality bakelite, convex, item no. 89414
- 2 – Tamper with stainless steel base with handle in high-quality bakelite, flat, item no. 89404
- 3 – Pressure-regulating tamper made of aluminium and stainless steel, item no. 89415
- 4 – Precision tamper flat with spacer made of stainless steel, handle in smoked oak, spacer made of copper, item no. 89406
- 5 – WDT Tool for an even consistency of the coffee grounds, item no. 89433
- 6 – Tamping station made of aluminium for stable tamping pressure, item no. 89429
- 7 – Tamperstation made of aluminium, powder-coated in anthracite, item no. 89431
- 8 – Height-adjustable stainless steel tamping station, adapts precisely to the most varied portafilters, item no. 89510



6

7

8



9

10

11

- 9 – Distributor for an even distribution of the coffee powder in the portafilter, item no. 89417
- 10 – Leveler helps keep the puck level while tamping, item no. 89416
- 11 – Funnel helps keep coffee grounds in your portafilter while grinding, item no. 89500



12

- 12 – Shot Mirror for an effortless monitoring of the coffee extraction, with magnetic fixture, item no. 89560



Espresso accessories



- 1 - **Knockbox** round in polished stainless steel, Ø 140 mm / H 165 mm, item no. 89622
- 2 - **Knockbox drawer slim** in polished stainless steel, W 140 x D 240 x H 90 mm, item no. 89625
- 3 - **Knockbox drawer M** in polished stainless steel, W 160 x D 240 x H 65 mm, item no. 89630
- 4 - **Knockbox drawer L** in polished stainless steel, W 205 x D 305 x H 65 mm, item no. 89611



4



- 5 - **Stainless steel milk pitcher** with scale inside the jug and professional spout for pouring latte art 360 ml, item no. 89460; 600 ml item no. 89461
- 6 - **Copper design milk pitcher** with scale inside the jug and professional spout, 450 ml, item no. 89462
- 7 - **Steam nozzle set** 3 / 4 / 5 holes, item no. 89453
- 8 - **Steam nozzle tornado** 5 holes, for particularly easy milk foaming, item no. P5950
- 9 - **Flow profile valve** for the ECM brew group to manually adjust the water flow in the brew group - for even more aroma, item no. P1061

7



8



9



Espresso accessories

Portafilter „Barista Style“

Ergonomically angled portafilter, balanced weight for optimal handling (fig. 1 to 4)



1

2

3

4

5

- 1 - **Premium stainless steel portafilter**, 1 spout, item no. 89471
- 2 - **Premium stainless steel portafilter**, 2 spouts, item no. 89472
- 3 - **Premium stainless steel portafilter**, bottomless, with 21g filter, item no. 89476
- 4 - **Chrome-plated portafilter**, bottomless with 21g filter, item no. 89426
- 5 - **Chrome-plated portafilter „Cialda“**, item no. C699900230
- 6 - **IMS precision basket**, 10-12 g, h: 20 mm, item no. 89556
- 7 - **IMS precision basket**, 18-20 g, h: 26 mm, item no. 89557
- 8 - **IMS precision basket**, 20-22 g, h: 28 mm, item no. 89558
- 9 - **IMS shower screen E61**, item no. 89555

6



7



8



9





Espresso accessories



2



3

4



- 1 - **Accessories Organizer**, convenient arrangement for portafilter, cleaning brush and steam nozzle, item no. 89432
Accessories not included
- 2 - **Tamper pad** made of water buffalo leather, item no. 89418
- 3 - **ECM barista towel** for ideal cleaning, item no. 89454
- 4 - **Equipment holder** for the perfect arrangement of your espresso accessories, item no. 89430
Accessories not included



Espresso accessories



1



2



3





4

- 1 - **ECM Espresso cups**, handmade of stoneware, each piece unique, packaging unit = 2, item no. 09510
- 2 - **ECM cappuccino cups**, handmade of stoneware, each piece unique, packaging unit = 2, item no. 09511
- 3 - **ECM espresso cups** in a retro design, packaging unit = 6 pieces, item no. 09505
- 4 - **ECM cappuccino cups** in a retro design, packaging unit = 6 pieces, item no. 09506



Product overview espresso machines

 Single boiler

 Heat exchanger

 Smart HX®

 Dual boiler



Modell	Puristika	Classika PID	Mechanika VI Slim	Mechanika Slim PID	Technika V Profi PID	Elektronika II Profi	Mechanika Max	Synchronika II
ECM brewing group with stainless steel brewing bell	■	■	■	■	■	■	■	■
Pump	vibration	vibration	vibration	vibration	rotary	rotary	rotary	rotary
Fast heat-up mode	approx. 11 min	approx. 11 min						approx. 6.5 min*
PID controller	■	■	■	■	■		■	■
Shot counter	■	■		■	■		■	■
Timer function							■	■
Valves		rotary valves	rotary valves	rotary valves	quick steam lever	quick steam lever	quick steam lever	quick steam lever
Steam (1) / hot water (2)		1	1 + 2	1 + 2	1 + 2	1 + 2	1 + 2	1 + 2
Fresh water tank	external, approx. 2 l	approx. 2.8 l	approx. 2.8 l	approx. 2.8 l	approx. 3 l	approx. 3 l	approx. 3 l	approx. 2.8 l
Switchable water tank / fixed water connection					■	■	■	■
Automatic water shortage shut-off		■	■	■	■	■	■	■
Volume stainless steel boiler	ca. 0.75 l	ca. 0.75 l	ca. 1.9 l	ca. 1.9 l	ca. 2.1 l	ca. 2.1 l	ca. 1.9 l	ca. 0.75 l coffee ca. 2 l steam/hot water
Boiler pressure gauge			■	■	■	■	■	■
Pump pressure gauge	■	■	■	■	■	■	■	■
Manually adjustable brewing pressure	■	■	■	■	■	■	■	■
Number of ECM portafilters	1	1	2	2	2	2	2	2
Weight	13.4 kg	18.5 kg	20.2 kg	20.2 kg	28 kg	29 kg	23.5 kg	30 kg
Dimensions W x D x H mm (without portafilter)	195 x 348 x 315	250 x 445 x 395	250 x 445 x 395	250 x 445 x 395	325 x 475 x 390	325 x 475 x 400	275 x 445 x 405	335 x 490 x 410
Item number	81025	81084	82046	82048	85285	84274	82295	86294

* high-speed heat-up through extra brew group heating

Product overview espresso grinders



Modell	C-Manuale 54	C-Automatik 54	S-Manuale 64	S-Automatik 64	V-Titan 64
Grinding mechanism	aluminium	aluminium	aluminium	aluminium	aluminium
Diameter burrs	54 mm	54 mm	64 mm	64 mm	64 mm
Material burrs	steel	steel	steel	steel	titanium coated
Stainless steel grinding adjustment			upgradable	upgradable	▪
Motor performance	235 W	235 W	450 W	450 W	450 W
Bean hopper capacity	250 g	250 g	500 g optional 1000 g	500 g optional 1000 g	500 g optional 1000 g
Display		▪		▪	▪
Dosing	manual	programmable	manual	programmable	programmable
Grind setting	graduated	stepless	stepless	stepless	stepless
Quantity counter display				▪	▪
Height-adjustable portafilter rest		▪	▪		▪
Stainless steel housing	polished (89050) powder-coated (89055)	polished	polished	polished (89150) powder-coated (89154)	polished (89250) powder-coated (89254)
Weight	5.1 kg	5.3 kg	6.9 kg	6.9 kg	9.8 kg
Dimensions w x d x h mm	115 x 175 x 355	130 x 170 x 357	145 x 200 x 415	145 x 200 x 415	200 x 260 x 445
Item number	89050 / 89055	89060	89100	89150 / 89154	89250 / 89254



we live espresso

ECM
MANUFACTURE

www.ecm.de

ECM® Espresso Coffee Machines Manufacture GmbH
Industriestraße 57-61, 69245 Bammental, Germany
Phone +49 6223-9255-0
E-Mail info@ecm.de

